

**WASHING
MACHINE
FJ 1200**

INSTRUCTION BOOKLET

CONTENTS

Warnings	Page	3
Installation	Page	4
Unpacking	Page	4
Positioning	Page	4
Water inlet	Page	4
Water drainage	Page	5
Levelling	Page	5
Electrical connection	Page	6
Getting to know your machine	Page	7
Control panel	Page	7-8
Washing hints	Page	9
Wash care symbols	Page	10
Use of detergent and additives	Page	11
Energetic wash cycles	Page	12
Gentle wash cycle	Page	13
Using your machine	Page	14
Washing 4 kg of white cotton at 95°C	Pages	14
Washing 2 kg of synthetic fabrics at 40°C	Pages	15
Washing 1 kg of wool fabrics at 40°C	Page	16-17
Maintenance and cleaning	Page	18
Descaling, after each wash, external cleaning	Page	18
Cleaning the dispenser drawer, cleaning the drawer recess, the dangers of freezing	Page	18
Cleaning the filter	Page	19
The water inlet filters	Page	19
Servicing	Page	20
Peace of mind for twelve months (Zanussi guarantee conditions)	Page	21

TECHNICAL SPECIFICATIONS

DIMENSIONS	Height	85 cm (33.5")
	Width	60 cm (23.6")
	Depth	57 cm (22.4")
POWER SUPPLY VOLTAGE		220-240 V/50 Hz
TOTAL POWER ABSORBED		2550 W (13A)
WATER PRESSURE	Minimum (hot)	5 psi (3.5 N/cm ²)
	Minimum (cold)	7 psi (4.8 N/cm ²)
	Maximum	110 psi (76 N/cm ²)
MAXIMUM RECOMMENDED LOAD	Cotton, linen	4.5 kg (10 lb)
	Synthetics, delicate fabrics	2 kg (4.5 lb)
	Wool	1 kg (2.2 lb)
SPIN SPEED	Maximum	1200 rpm

This appliance complies with E.E.C. directive No. 87/308 of 2.6.87 relative to radio interference suppression.

IMPORTANT INFORMATION

It is most important that this instruction book should be retained with the appliance for future reference. Should the appliance be sold or transferred to another owner, or should you move house and leave the appliance, always ensure that the book is supplied with the appliance in order that the new owner can get to know the functioning of the appliance and the relevant warnings.

These warnings have been provided in the interest of safety. You MUST read them carefully before installing or using the appliance.

- This appliance is designed to be operated by adults. Children should not be allowed to tamper with the controls or play with the product.
- It is dangerous to alter the specifications or attempt to modify this product in any way.
- Any electrical work required to install this appliance should be carried out by a qualified electrician or competent person.
- Any plumbing work required to install this appliance should be carried out by a qualified plumber or competent person.
- This product should be serviced by an authorised Zanussi Service Centre, and only genuine Zanussi spare parts should be used.
- Care must be taken to ensure that the appliance does not stand on the electrical supply cable.
- Always unplug the appliance and turn off the water after use.
- Do not overload the appliance. See relevant section in instruction book.
- Always look through the glass door to check if water has drained before opening the door. If water is present do not open door before draining the water. If in doubt, refer to your instruction book.
- This appliance is heavy. Care should be taken when moving it.
- All packing and transit bolts must be removed before use. Serious damage can occur to the product and to property if this is not adhered to. See relevant section in instructions.
- The glass door becomes very hot during the washing cycle. Keep children away from the vicinity of the appliance whilst it is in operation.
- Leave the porthole door slightly ajar between washes to preserve the door seal.
- Only wash fabrics which are designed to be machine washed. If in doubt, consult the manufacturer of that item.
- Before washing, ensure that all pockets are empty and buttons and zips are fastened. Avoid washing frayed or torn articles and treat stains such as paint, ink, rust, and grass before washing. Underwired bras must NOT be machine washed.
- Any objects such as coins, safety pins, nails, screws, stones or any other hard, sharp material can cause extensive damage and must not be placed into the machine.
- Garments which have been in contact with volatile petroleum products should not be machine washed. If volatile cleaning fluids are used, care should be taken to ensure that the fluid is removed from the garment before placing in the machine.
- Wash small items such as socks, laces, washable belts etc in a washing bag or pillow case as it is possible for such items to slip down between the tub and the inner drum.
- Only use the advised quantities of fabric softener. Damage to the fabric can ensue if you over-fill. Refer to the manufacturer's recommendations of quantities.
- As some duvets and eiderdowns should be washed in large commercial machines because of their bulk. Please check with the manufacturer of the item before washing in a domestic machine.
- The users should always check that they have not left their gas lighters (disposable or otherwise) in their clothing.
- Pets and children have been known to climb into washing machines. Please check your drum before use.
- **If the machine is situated on a carpeted floor, please adjust the feet in order to allow air to circulate freely.**
- Under no circumstances should you attempt to repair the machine yourself. Repairs carried out by inexperienced persons may cause injury or serious malfunctioning. Contact your local Zanussi Service Centre. Always insist on genuine Zanussi spare parts.

This machine incorporates new Electronic Technology and therefore may work differently from a traditional product which you have become accustomed to. If you are concerned about the operation of the machine please study the instruction book carefully, as it contains advice about the way in which the new technology affects the operation during normal use.

INSTALLATION

Unpacking

Before starting the machine up, the packing must be removed as follows.

You are advised to keep all the packaging for re-use in case the machine is to be transported again.

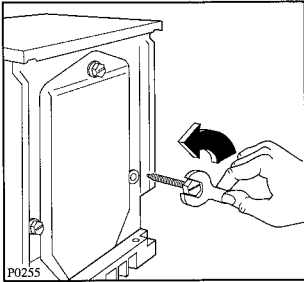

Unscrew and remove the rear right bolt (using a spanner). Lay the machine gently on its back, making sure that the hoses are not squashed.

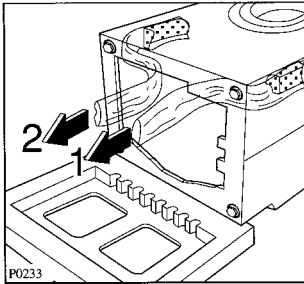
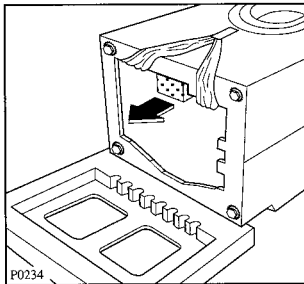

Remove the polystyrene block from the bottom of the machine.

Carefully slide out the right polythene bag (1), removing it toward the centre of the machine.

Repeat the operation for the left polythene bag (2), removing it toward the centre of the machine.

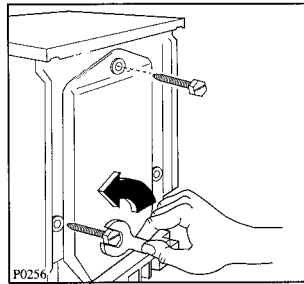

Remove the polystyrene base, set the machine upright and unscrew the two remaining rear bolts.

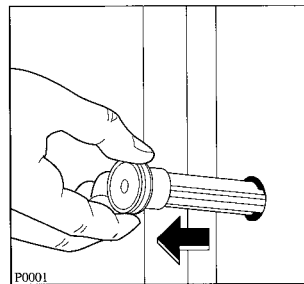

Slide out the 3 plastic spacers and plug the 3 holes with the 3 plastic plugs which you find at the back of the machine.

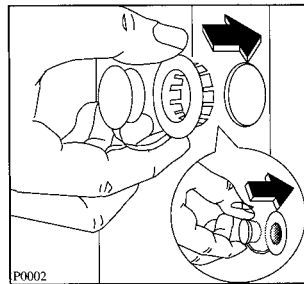

Positioning

Your new Zanussi washing machine has been designed to be permanently plumbed in to your home's water supply and drainage system. However, if this is not possible, it may be connected to suitable existing taps, with the drain hose discharging into a sink.

The appliance has two inlet hoses, hot and cold, with female $\frac{3}{4}$ " BSP thread connectors. If this connection is not compatible with the plumbing of the existing installation, a variety of connectors are available from good hardware stores and plumbers merchants to suit most domestic plumbing. Any alterations to your existing plumbing must be carried out by a competent person, or qualified plumber.

Water inlet

The inlets on the back of the appliance are colour coded, blue for cold and red for hot.

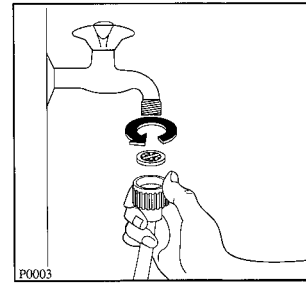

Before connecting the hoses be sure to fit the mesh filters supplied as per diagram.

If only a cold water supply is available, connect the two hoses to a cold water outlet by means of a 'Y' connection piece.

Installation should comply with local water authority and building regulations' requirements.

The appliance must be given a separate cold water supply and not be connected to a mixer tap, a single outlet water heater or a booster pump. A minimum water pressure of 7psi is required for safe operation of the appliance.

If you cannot make the cold water connection direct from the rising mains, you may be able to operate the appliance from your cold water storage system.

There should be a minimum distance of 5.02m (16 $\frac{1}{2}$ ft) between the appliance's inlet and the bottom of the tank.

There will be sufficient pressure for the hot water supply from the hot water cylinder if the height between the appliance's inlet and the bottom of the cold water storage cistern (not between the appliance and hot water cylinder) is at least 2.74m (9ft).

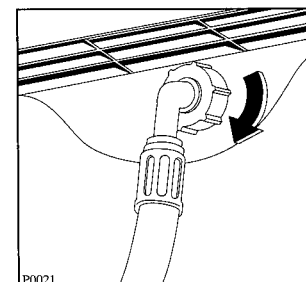

Set the hoses correctly by loosening the ring nuts. After positioning the inlet hoses, be sure to tighten the ring nuts again to prevent leaks.

INSTALLATION

Water drainage

If you intend the drain hose from the machine to empty into a sink, make sure that the sink is empty and that the plug hole is not blocked.

If the machine is permanently plumbed in, hook the end of the hose into a standpipe installed for the purpose. The standpipe must have an internal diameter of at least 40 mm (1 1/2") in order that there is an air gap between the drain hose and the standpipe. Make sure, that it is designed in such a way, that the end of the drain hose cannot be covered with water.

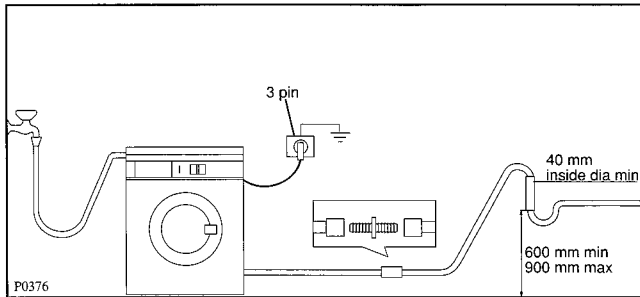

Important

Before connecting up the machine to new pipework or to pipework that has not been used for some time, run off a reasonable amount of water to flush out any debris that may have collected in the pipes.

Whether discharging into a sink or a standpipe check that the end of the drain hose is neither too high nor too low. The top of the curve in the hose's end should be no more than 90cm (35.4"), and no less than 60cm (23.6") above floor level.

Levelling

Level the washing machine by loosening or tightening the feet. Accurate levelling prevents vibration, noise and displacement of the machine during operation. After levelling the machine, secure the feet by tightening the ring nuts with the aid of a screwdriver.

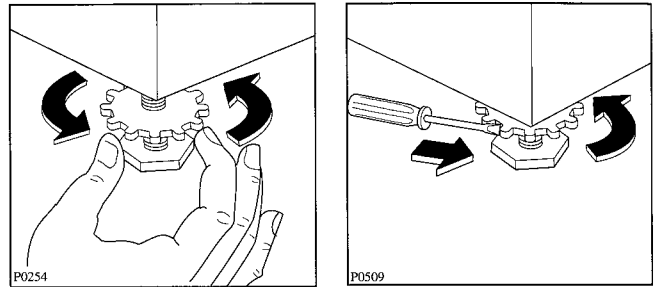

Some vibration is inevitable, especially if mounted on a wooden floor.

Sprung wooden floors are particularly susceptible to vibration. For advice, consult a builder. If possible, always place the machine on a solid floor.

Special conditions

If the floor is carpeted with a deep-pile carpet or covered with crumbly or soft material, insert a rigid support base under the feet to prevent noise, vibration or displacement. The base should protrude a few centimetres beyond the edges of the machine.

Warning

The machine should NOT be placed on deep pile carpeting.

Note

Please ensure that when the appliance is installed it is easily accessible for the engineer in the event of a breakdown.

All plumbing and electrical work required to install this appliance must be carried out by competent persons or qualified plumbers or electricians.

Electrical connections

WARNING: THIS APPLIANCE MUST BE EARTHED.

The manufacturer declines any liability should this safety measure not be observed.

If the plug that is fitted to your appliance is not suitable for your socket outlet, it must be cut off and the appropriate plug fitted.

Remove the fuse from the cut off plug.

The cut off plug should then be disposed of to prevent the hazard of shocks in case it should be plugged into a 13 Amp socket in another part of your home.

IMPORTANT

The wires in the mains lead are coloured in accordance with the following code:

Green and Yellow	- Earth
Blue	- Neutral
Brown	- Live

If you fit your own plug, the colours of the wires in the mains lead of your appliance may not correspond with the markings identifying the terminals in your plug, proceed as follows:

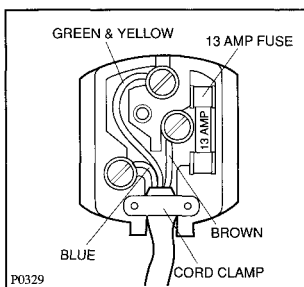

Connect the green and yellow (earth) wire to the terminal in the plug which is marked with the letter «E» or the earth symbol \perp or coloured green and yellow.

Connect the blue (neutral) wire to the terminal in the plug which is marked with the letter «N» or coloured black.

Connect the brown (live) wire to the terminal in the plug which is marked with the letter «L» or coloured red.

The plug moulded on to the lead incorporates a fuse. For replacement, use a 13 Amp BS1362 fuse. Only ASTA or BSI approved fuses should be used.

The plug must not be used if the fuse cover/carrier is lost. The cover/carrier is indicated by the coloured insert at the base of the plug.

A replacement cover/carrier must be obtained from your local Zanussi Service Force Centre whose address is listed in the Customer Care Booklet which accompanies your instruction manual.

GETTING TO KNOW YOUR MACHINE

Control panel

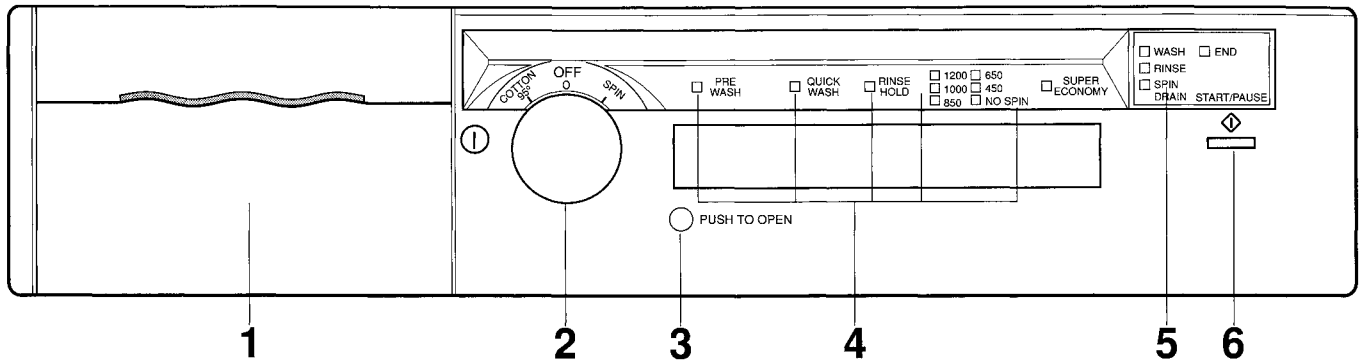

- 1 Detergent dispenser drawer
- 2 Programme selector dial
- 3 Programme option cover
- 4 Programme option lights
- 5 Programme indicator lights
- 6 START/PAUSE button

Detergent dispenser drawer

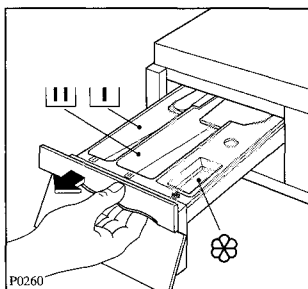

Symbols

- Pre-wash
- Wash
- Fabric softener

Programme selector dial

To select a programme depress the selector dial to release and then turn to the required programme.

The machine will emit one or two audible bleeps: one bleep if the programme you have selected follows another programme, two bleeps if the selection is made starting from the OFF position. Depending on the selected programme, one or more indicator lights (5) will illuminate.

If you select the programme for "delicates", the indicator light NO SPIN will illuminate showing that the spin cannot take place for this programme.

During a selected programme the programme selector dial will remain in the same position. The programme stage will be shown by the programme indicator lights.

To switch the machine off and to cancel a programme already in progress turn the programme selector dial to «OFF».

Programme option cover

To display the programme options depress the button (3).

By depressing any of the buttons the machine will emit an audible bleep indicating that the option selected has been accepted.

Programme indicator lights

As the machine progresses through a selected programme each phase will be indicated ie: WASH, (including Prewash, if this option has been selected) RINSE, SPIN, and END.

Programme option lights

The programme option lights will illuminate if the PRE-WASH, QUICK WASH, RINSE HOLD or SUPER ECONOMY options are selected. It will also indicate the selected SPIN SPEED.

START/PAUSE button

Once a programme has been selected press the START/PAUSE button until the audible bleep stops, then release. The programme will then commence.

NOTE: There may be a delay of up to 30 secs from releasing the button until the programme commences during which time the door lock light may flash.

This button can be used also to drain the water of the last rinse on programmes for synthetics and delicates (see RINSE HOLD button on page 8).

If you have to open the door during a programme, press the START/PAUSE button until the audible bleep stops, wait approx. 2 minutes before opening the door to give the electric locking mechanism time to release it (the door locked light must be off) and then open the door.

After closing the door press the button until the audible bleep stops to allow the programme to continue.

If the machine emits 3 successive bleeps it means that the chosen option is not compatible with the selected programme.

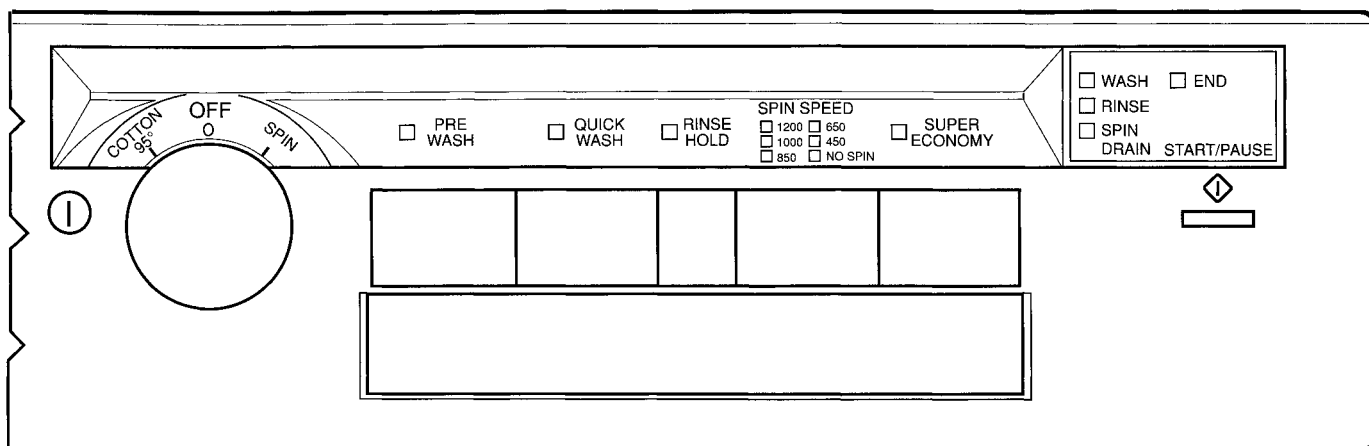

PREWASH button

For heavily soiled laundry. Depress this button to carry out a prewash at a 40°C temperature.

This option cannot be used in conjunction with ECONOMY or QUICK WASH as these are not compatible.

The prewash option cannot be selected for **wool**.

The prewash light will illuminate together with an audible bleep to show the option has been accepted.

QUICK WASH button

Depress this button to reduce the wash time on cotton programmes by 20 mins and synthetic programmes by 15 mins. It is ideal for fabrics which are lightly soiled.

This option cannot be used in conjunction with ECONOMY or PREWASH as these are not compatible.

The QUICK WASH light will illuminate together with an audible bleep to show the option has been accepted.

RINSE HOLD button

Press this button to make the machine stop with water in the drum after the synthetic or delicate wash cycles. This prevents any creasing which may take place if the clothes are left damp in the drum. When it is convenient for you to empty the machine, press the START/PAUSE button: the clothes will be gently spun at the speed that you have previously selected (for synthetics) or the machine will carry out only a drain (for delicates).

SPIN SPEED button

The machine selects automatically the spin speed compatible to the selected programme.

If you wish to select another speed or exclude all spinning, depress this button until the required spin speed is displayed and the relevant light will illuminate.

By depressing any of the buttons the machine will emit an audible bleep indicating that the option selected has been accepted.

IMPORTANT: If you select 850 rpm or less on programmes for cotton and linen, the machine will carry out automatically an extra rinse.

If you select 650 rpm or less on a synthetic wash programme, the machine will automatically increase the water level on each rinse.

SUPER ECONOMY button

This programme gives you the option of reducing the wash temperature.

It is particularly useful when the items require an intensive wash and the fabric does not allow a higher temperature. The wash programme will be increased by approx. 20 mins for cotton programmes.

The temperature reduction will be:

COTTON 95°C will be reduced to 60°C

COTTON 60°C will be reduced to 40°C

SYNTHETICS 50°C will be reduced to 40°C

This option cannot be used with PREWASH or QUICK WASH.

The super economy light will illuminate together with an audible bleep to show the option has been selected.

IMPORTANT: To switch the machine off or cancel a programme turn the programme selector dial to the OFF position. The door can be opened after 2 mins allowing for the door lock mechanism to be released, providing the water level is not above the base of the door.

Note: If in doubt select the drain programme prior to opening the door.

If the machine emits 3 successive beeps it means that the chosen option is not compatible with the selected programme.

Washing hints

Do **NOT** overload the machine. Weigh the laundry the first few times you use the appliance.

The average weights of the most common items are listed below as a guide:

1000g = 1 kg



















Sheet	700-1000 g
Pillow case	100-200 g
Tablecloth	400-500 g
Serviette	50-100 g
Tea towel	70-120 g
Linen hand towel	100-150 g
Towelling hand towel	150-250 g
Towelling bath towel	700-1000 g
Bath robe	1000-1500 g
Man's shirt	200-300 g
Apron	150-200 g

- Some stains such as fruit, wine, grass, rust etc. are difficult to remove and should be treated before washing with specific products, which can be found in most household shops. In some cases it may help to soak the stain before washing with a special pre-soak product or biological detergent.
 - Only wool marked "Pure New Wool - washable, preshrunk" can be washed in the machine using the wool programme; other types of wool should be washed by hand or dry cleaned.
 - Once you have finished using the machine, you are advised to unplug it and turn off the water tap.
-
- Load the laundry loosely alternating large items with small ones.
 - Sort the laundry according to the type of fabric, colour-fastness and how dirty it is.
 - Avoid washing unhemmed or torn items as they may unravel.
 - Before washing, empty all pockets of small objects which may have been left inside (coins, keys, screws etc), as these could damage the drain pump.
 - When washing curtains, remove the hooks.
 - Close poppers and zips and fasten loose buttons.
 - It is essential to wash new coloured items separately when washing for the first time.
 - When washing fabrics requiring different wash temperatures together, always select the lowest temperature.
 - White items should not be washed with coloured items.
 - Very small items (handkerchiefs, ribbons, socks etc) should be washed in a washing bag or a pillow case.
 - Use a good quality detergent suitable for automatic washing machines.
 - Use the correct quantities of detergent.
 - For wool, use gentle detergent only in small quantities.
 - Bleach is very corrosive; it should be used with care and kept out of reach of children.

Wash care symbols

The familiar wash code symbols which are found on the care labels in most clothes are disappearing and a new set is introduced. The change is due to changes in

fabrics and detergents and because people are tending to use fewer programmes and mix fabrics in one load. The change brings the codes into line with the labelling used in the rest of Europe.

Old Symbol	New Symbol	Wash Action	Fabric
		Normal (Maximum)	White Cotton or Linen without Special Finishes
		Normal (Maximum)	Cotton, Linen or Viscose without Special Finishes Colourfast at 60°C.
	No longer used. White Nylon, Polyester/Cotton mixtures now included in 		
		Reduced (Medium)	Nylon, Polyester/Cotton, Viscose with Special Finishes: Cotton/Acrylic Mix.
		Normal (Maximum)	Cotton, Linen or Viscose Colourfast at 40°C but not 60°C.
		Reduced (Medium)	Acrylics, Acetate, Triacetate, Wool mixes, Polyester/wool blends.
		Much Reduced (Minimum)	Wool, wool mixes. Silks.
	No longer used. Silk now included in  printed acetate included in 		
	No longer used.		

The new wash symbols appear on the side of Washing Powder packets.

WHICH DETERGENT ?

To ensure you obtain the best wash results from your appliance, it is important to use the right detergent in your everyday wash, and only detergents recommended for use in automatic machines.

To maintain the appearance of your clothes and household textiles and to make them last longer you should use different types of detergent for different washes, whether for whites, colours or delicates.

Whites

We recommend the Ariel product range which is biological and designed to provide excellent cleaning and stain removal even at low temperatures.



Non Biological

If you prefer to use a non biological detergent, which does not contain enzymes we recommend Fairy. Fairy provides good cleaning and stain removal.



Coloureds

For coloured items you should use a detergent which is designed to clean while maintaining the original colour. Ariel Color does not contain bleach and therefore helps to preserve colours.



Delicate Items

When washing delicates such as woollens, you should use a product which is specially designed to care for fine fabrics. Dreft Automatic is suitable for woollens and other delicates.



Laundry Bleach

For additional stain removal you may wish to use a product such as Ace Gentle Bleach which is used in addition to your chosen detergent. Ace is suitable for all washable fabrics including silks, woollens and coloureds.



AND IN WHICH FORM ?

Not only are there different types of detergent, but they are also available in different forms. Whether you choose a powder or liquid in traditional or compact form is down to personal choice.

Traditional Powders

Pour the powder directly into the dispenser drawer. Do not sprinkle powder onto clothes in the machine drum.

Traditional Liquids

Liquid can be placed in the main wash compartment of the detergent drawer marked with the symbol , start the machine immediately upon placing the detergent in the dispenser drawer. Alternatively the detergent is measured into the specially designed dosing device* which should be placed on top of the laundry, and at the back of the machine drum.

Compact Powders and Liquids

Compact detergents (or concentrates as they are also known) are available in liquid or powder form, and generally require a smaller dosage. Follow the manufacturer's instructions to ensure the most economical usage. Pour the detergent directly into the dispenser drawer, or alternatively measure the detergent into the specially designed dosing device* which should be placed on top of the laundry, and at the back of the machine drum.

- * *If you use a dosing device in a washer dryer, please ensure the dosing device/ball is removed before carrying out a drying programme.*

Fabric Conditioners

These are ideal for improving 'softness', and also reduce static cling on synthetics and make ironing easier. They are available in two types:

For example Lenor liquid fabric softener, for use in the **washing machine/washer dryer**. The liquid fabric softener should be poured into the compartment marked with the symbol . Follow the manufacturer's dosage instructions and never exceed the MAX level.



Bounce conditioning sheets for use in a **tumble dryer**. We recommend the conditioning sheets are pinned (using a safety pin) to an article of laundry and placed in the tumble dryer.



Energetic wash cycles for cotton and linen

Recommended load: max. 4.5 kg

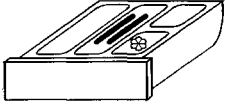
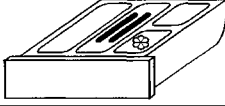
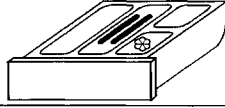
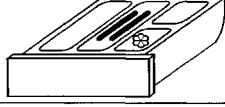
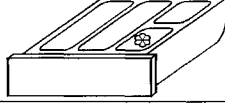
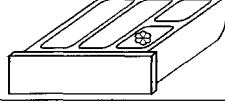
Programme	Degree of soil	Compartments to use	Programme dial position	Cycle description
Whites	Heavy		COTTON 95°	Wash at 95°C Rinses Spin
Whites	Light		COTTON 60°	Wash at 60°C Rinses Spin
Fast Coloureds	Normal		COTTON 60°	Wash at 60°C Rinses Spin
Non-fast Coloureds	Normal		COTTON 40°	Wash at 40°C Rinses Spin
Rinses			RINSES	Rinses with additive, if required Spin
Freshen up			SOFTENER	Softener rinse Spin
Drain			DRAIN	Draining of water
Spin			SPIN	Draining of water and spin

Water filling: 40° programmes - **cold** water filling

50°/60°/90° programmes: **hot** and **cold** filling

To cancel a programme already in progress turn the programme selector dial to "OFF" and then select the required programme.



PRE-WASH: can be used on all cotton wash programmes: see page 8

SUPER ECONOMY: can be used on all 95°C and 60°C programmes: see page 8

QUICK WASH: can be used on all cotton wash programmes: see page 8

Gentle wash cycles for synthetics, delicates and wool

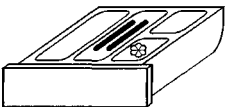
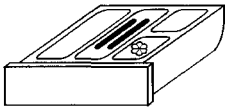
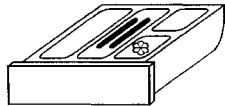
Recommended load: max. 2 kg (wool 1 kg)

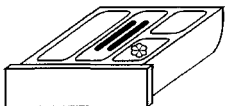
Programme	Degree of soil	Compartments to use	Programme dial position	Cycle description
Synthetics	Heavy		SYNTHETICS 50°	Wash at 50°C Rinses Short spin
Synthetics	Light		SYNTHETICS 40°	Wash at 40°C Rinses Short spin
Delicates	Normal		DELICATES 30°	Wash at 30°C Rinses Drain
Wool 	Normal		WOOL 40°	Wash at 40°C Rinses Spin For «Pure New Wool- washable, preshrunk»
Drain			DRAIN	Draining of water

To cancel a programme already in progress turn the programme selector dial to "OFF" and then select the required programme.

PRE-WASH: can be used on 50°C, 40°C synthetic and 30°C delicate programmes, cannot be used on wool programme: see page 8

QUICK WASH: can be used on 50°C and 40°C synthetic programmes only: see page 8.

RINSE HOLD: can be used on programmes for synthetics and delicates: see page 8.

If the water of the last rinse is not drained, the machine will drain the water automatically after 18 hrs.

SUPER ECONOMY: can be used on 50°C synthetic programme only: see page 8.

USING YOUR MACHINE

WASHING 4 KG OF WHITE COTTON AT 95°C

Suppose you have 4 kg of normally dirty laundry to wash. It is white cotton and is suitable for high temperature washing.

1 Load the laundry

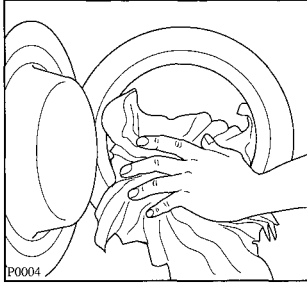

Open the door by pulling the catch outward.

Load the items one at a time and close the door.

2 Measure out the detergent

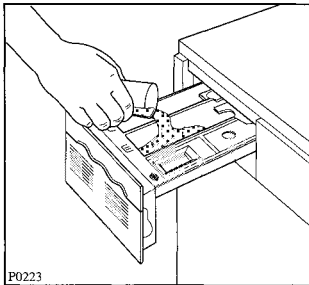
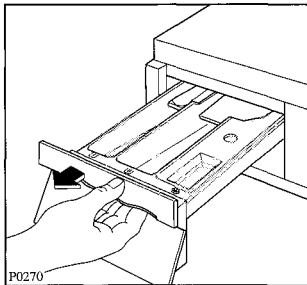

Pull out the detergent dispenser drawer from the control panel. Measure out the amount of detergent required and pour into the main wash compartment.

If you wish to carry out a prewash, pour the amount of detergent required into the "prewash" compartment.

3 Add the fabric softener if required

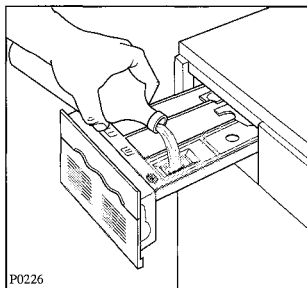

Pour the fabric softener, if required, into the compartment marked .

Do not exceed the MAX level and then close the drawer gently.

4 Select the programme

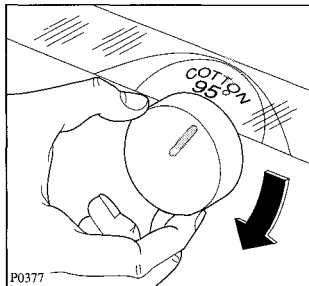
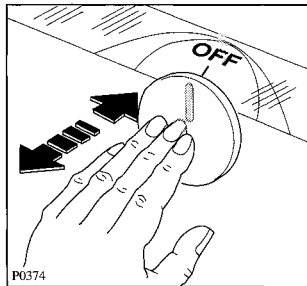

Depress the programme selector dial to release and then turn it to the required programme. The machine will emit one or two audible bleeps (see page 7) and the lights corresponding to the chosen programme will illuminate.

5 To choose the required options

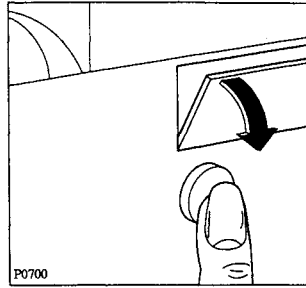

To gain access to the different push-buttons, open the programme option cover by depressing the cover button, and select the required option.

Confirmation of your selection will be indicated by an audible bleep and the relevant light will illuminate.

If you wish to reduce the spin speed which has been pre-selected by the machine, depress the relevant button until the light corresponding to the spin speed required illuminates.

6 Start the machine

Before starting up the machine check that:

- the appliance is plugged in
- the water supply taps are turned on
- the drain hose is correctly and securely positioned
- the door and the detergent dispenser drawer are closed.

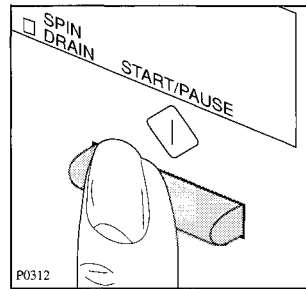

Depress the START/PAUSE button for approx 3 secs until the audible sound stops, then release. The programme will then commence.

NOTE: There may be a delay of up to 30 secs from releasing the button until the programme commences during which time the door locked light may flash.

7 At the end of the programme

The machine stops automatically and the "END" light will illuminate.

The door is controlled by a safety device which releases 2 minutes after the end of the programme. When the door locked light is off the door can be opened and 3 bleeps will be emitted every 20 secs for a period of 2 mins.

The buzzer can be stopped by turning the programme selector dial to "OFF" or by selecting another programme.

If the door locked light remains alight that means there is water in the drum. Select a drain programme to ensure the drum is empty.

To switch the machine off turn the programme selector dial to "OFF". All the lights will go out.

When the programme has finished you are advised to unplug the appliance and turn off the water taps.

WASHING 2 KG OF SYNTHETIC FABRICS AT 40°C

Suppose you have 2 kg of synthetic fabric laundry to wash. They are rather delicate fabrics and should not be washed at a high temperature.

1 Load the laundry

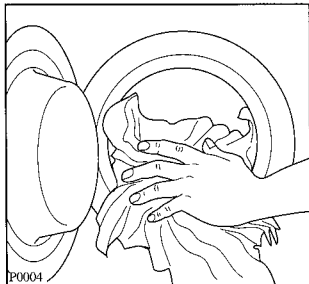

Open the door by pulling the catch outward.

Load the items one at a time and close the door.

2 Measure out the detergent

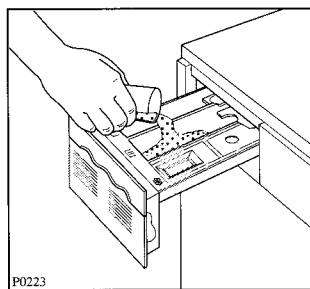
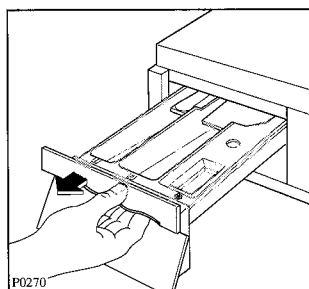

Pull out the detergent dispenser drawer from the control panel. Measure out the amount of detergent required and pour into the main wash compartment.

3 Add the fabric softener if required

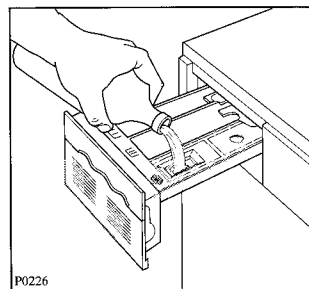

Pour the fabric softener, if required, into the compartment marked .

Do not exceed the MAX level and then close the drawer gently.

4 Select the programme

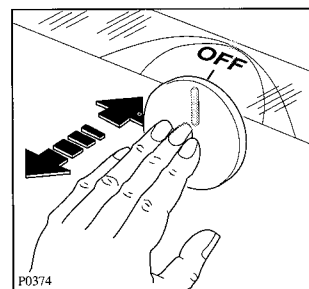

Depress the programme selector dial to release and then turn it to the required programme. The machine will emit one or two audible bleeps (see page 7) and the lights corresponding to the chosen programme will illuminate.

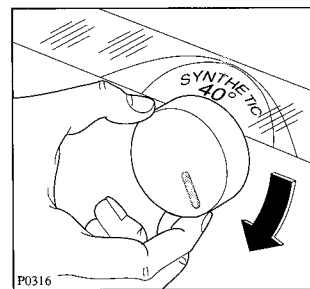

5 To choose the required options

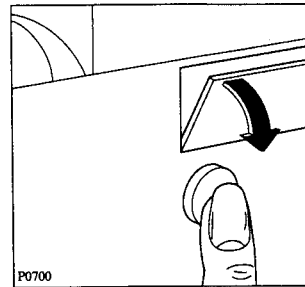

To gain access to the different push-buttons, open the programme option cover by depressing the cover button, and select the required option. Confirmation of your selection will be indicated by an audible bleep and the relevant light will illuminate.

If you wish to reduce the spin speed which has been pre-selected by the machine, depress the relevant button until the light corresponding to the spin speed required illuminates.

6 Start the machine

Before starting up the machine check that:

- the appliance is plugged in
- the water supply taps are turned on
- the drain hose is correctly and securely positioned
- the door and the detergent dispenser drawer are closed.

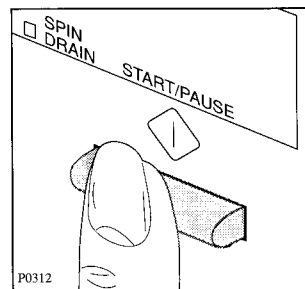

Depress the START/PAUSE button for approx 3 secs until the audible sound stops, then release. The programme will then commence.

NOTE: There may be a delay of up to 30 secs from releasing the button until the programme commences during which time the door locked light may flash.

7 At the end of the programme

The programme will end with a short spin.

If you have selected the RINSE HOLD option, the "RINSE" light will flash.

To drain the water depress the "START/PAUSE" button. The "SPIN SPEED" light will illuminate.

Ensure that the spin speed you require has been selected, if not, reselect.

The machine will drain and carry out a short spin. The "END" light will illuminate.

The door is controlled by a safety device which releases 2 minutes after the end of the programme. When the door locked light is off the door can be opened and 3 bleeps will be emitted every 20 secs for a period of 2 mins.

If the door locked light remains alight that means there is water in the drum. Select a drain programme to ensure the drum is empty.

To switch the machine off turn the programme selector dial to "OFF". All the lights will go out.

When the programme has finished you are advised to unplug the appliance and turn off the water taps.

WASHING 1 KG OF WOOL FABRICS AT 40°C

Suppose you have 1 kg of wool to wash.

1 Load the laundry

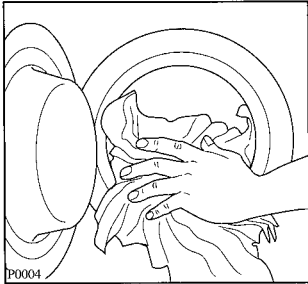

Open the door by pulling the catch outward.

Load the items one at a time and close the door.

2 Measure out the detergent

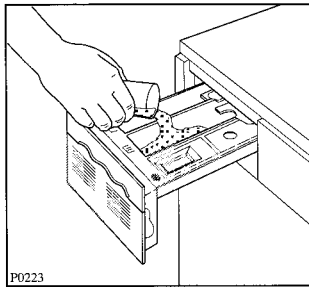
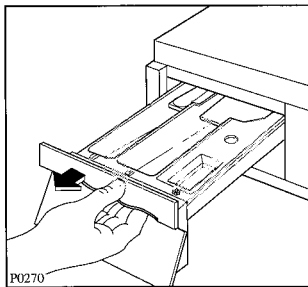

Pull out the detergent dispenser drawer from the control panel. Measure out the amount of detergent required and pour into the main wash compartment.

3 Add the fabric softener if required

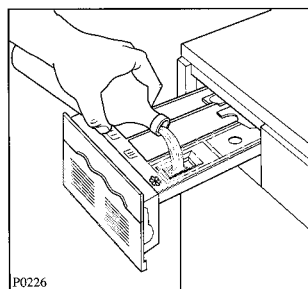

Pour the fabric softener, if required, into the compartment marked .

Do not exceed the MAX level and then close the drawer gently.

4 Select the programme

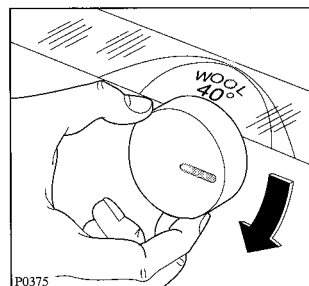
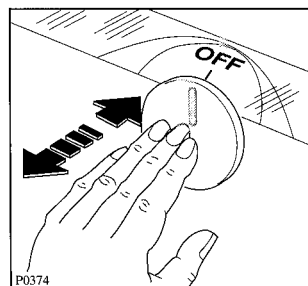

Depress the programme selector dial to release and then turn it to the required programme. The machine will emit one or two audible beeps (see page 7) and the lights corresponding to the chosen programme will illuminate.

5 To choose the required options

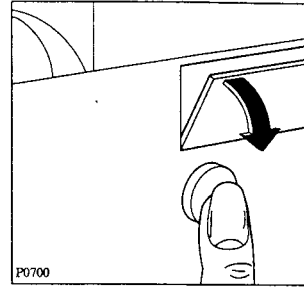

To gain access to the different push-buttons, open the programme option cover by depressing the cover button.

If you wish to reduce the spin speed which has been pre-selected by the machine, depress the relevant button until the light corresponding to the spin speed required illuminates.

6 Start the machine

Before starting up the machine check that:

- the appliance is plugged in
- the water supply taps are turned on
- the drain hose is correctly and securely positioned
- the door and the detergent dispenser drawer are closed.

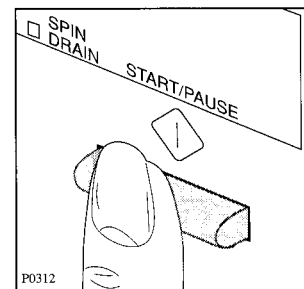

Depress the START/PAUSE button for approx 3 secs until the audible sound stops, then release. The programme will then commence.

NOTE: There may be a delay of up to 30 secs from releasing the button until the programme commences during which time the door locked light may flash.

During the wool programme the drum has a three quarter rotation action, and a long rest period between the clockwise and anticlockwise action. This is to ensure the wool is not damaged.

7 At the end of the programme

The programme will end with a spin.

The "SPIN SPEED" light will illuminate.

Ensure that the spin speed you require has been selected, if not, reselect.

The machine will drain and carry out a short spin. The "END" light will illuminate.

The door is controlled by a safety device which releases 2 minutes after the end of the programme. When the door locked light is off the door can be opened and 3 beeps will be emitted every 20 secs for a period of 2 mins.

To switch the machine off turn the programme selector dial to "OFF". All the lights will go out.

When the programme has finished you are advised to unplug the appliance and turn off the water taps.

MAINTENANCE AND CLEANING

Before any maintenance or cleaning is carried out you must **DISCONNECT** the appliance from the electricity supply.

Descaling

The water we normally use contains lime. It is a good idea to periodically use a water softening powder in the machine. Do this separately from any laundry washing, and according to the softening powder manufacturer's instructions. This will help to prevent the formation of lime deposits.

After each wash

Leave the door open for a while. This helps to prevent mould and stagnant smells forming inside the appliance. Keeping the door open after a wash will also help to preserve the door seal.

External cleaning

Clean the exterior cabinet of the appliance with soap and water only, and then dry thoroughly.

Cleaning the dispenser drawer

From time to time the washing powder and additive dispenser drawer should be cleaned.

Pull the drawer to remove and flush it out under a tap, to remove any traces of accumulated powder.

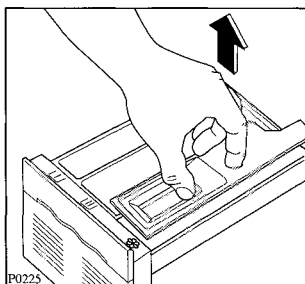
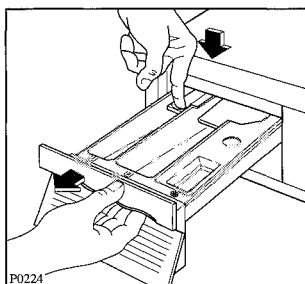

Cleaning the drawer recess

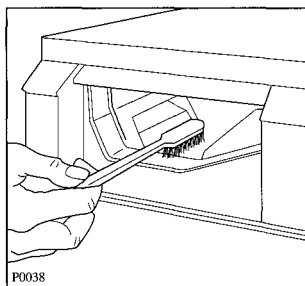

Having removed the drawer, use a small brush to clean the recess, ensuring that all washing powder residue is removed from the upper and lower part of the recess.

Replace the drawer and run the rinse programme for a few minutes without any clothes in the drum.

The dangers of freezing

If the machine is exposed to temperatures below 0°C, certain precautions should be taken.

- Turn off the water taps.
- Select a wash programme and run for a few seconds.
- Unscrew the inlet hoses.
- Unhook the drain hose from the rear support and position the end in a bowl. Run the draining programme for a few seconds.
- When you intend to start the machine up again, make sure that the room temperature is above 0°C.

Cleaning the filter

The water drain filter

A clean filter is important for the correct functioning of the machine, and should therefore be cleaned after every wash.

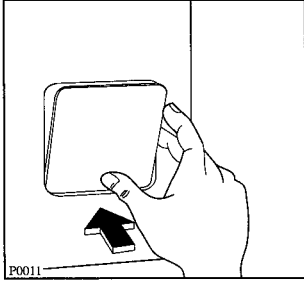

Open the filter door and place a container underneath to catch any spillage. If the filter is blocked and the machine is unable to drain you will need to drain the water manually from the machine at this stage. To do this,

unhook the drain hose from the standpipe or sink and hold the end of the hose over a bowl on the floor. The water should drain by gravity into the bowl. When the bowl is full, hook the hose back up and empty the bowl. Repeat the procedure until water stops flowing out.

Unscrew and remove the filter.

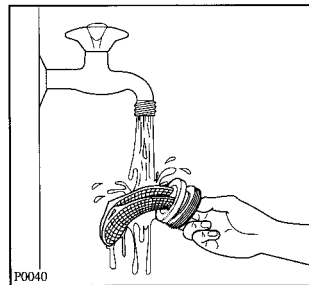
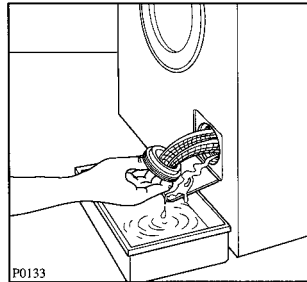
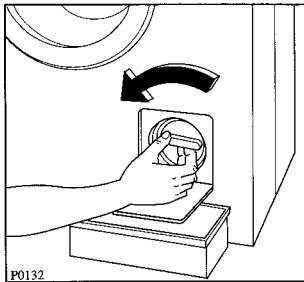

Clean carefully under a fast running tap.

Warning

When the appliance is in use and depending on the programme selected there can be hot water in the filter. Never remove the filter during a wash cycle, always wait until the appliance has finished the cycle, and is empty. When replacing the filter, ensure it is securely retightened so as to stop leaks and young children being able to remove it.

The water inlet filters

If your water is very hard or contains traces of lime deposit, the water inlet filters may become clogged.

It is therefore a good idea to clean them from time to time.

Turn off the water taps. Unscrew the water inlet hoses.

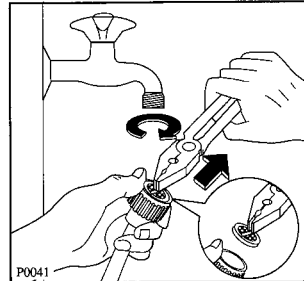

Remove and clean the filters using a hard bristle brush. Replace the filters and tighten up the inlet hoses.

SERVICING

Before contacting your local Zanussi Service Centre, please make the following checks:

The machine does not start up

- The START-button has not been pressed until the audible sound stops
- The door is not closed properly
- No water is entering the machine (see: the machine does not fill)

The machine does not fill

- The water taps are not turned on
- The water supply has been disconnected.
- The inlet hoses are kinked
- The water pressure is too low
- The water inlet filters are clogged

The machine empties as it fills

- The end of the drain hose is too low
- The end of the drain hose is submerged in water
- Drain pipe has no vent-hole

The machine does not drain or spin

- You have selected a gentle wash cycle with the RINSE HOLD option
- The drain filter is clogged
- The drain hose is kinked
- The drainage system pipes are blocked
- The drain hose extension is incorrect

The machine leaks or overflows

- Too much detergent
- Unsuitable detergent
- The inlet hose is loose
- The detergent dispenser drawer or recess is clogged
- The end of the drain hose is not securely positioned

The machine vibrates or is noisy

- The internal packing has not been removed
- The machine is not level
- The machine is in contact with the wall or furniture
- The washing load is badly distributed
- The machine is overloaded

The door does not open

- The safety device has locked it (door locked light on)
- Water in the wash tub

Important:

All machines are checked before leaving the factory. When using your appliance for the first time, it may happen that the buzzer sounds uninterruptedly when you select the programme.

That is due to the fact that the machine was subjected to the autodiagnosis test in the factory. In this case turn the programme selector dial to "OFF", wait at least 15 secs and reselect the programme.

If, after the above checks, there is still a fault, call your local Zanussi Service Centre, whose address can be found in the accompanying Customer Care Booklet, and can also be found in your local telephone directory under «Z». Please make sure you give the model and serial number of the appliance.

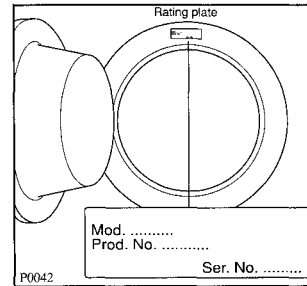

This information can be found on the rating plate (see picture) or on the guarantee card.

Original spare parts can be purchased from Zanussi Service Centres.

In-guarantee customers should ensure that the above checks have been made as the engineer will make a charge if the fault is not a mechanical or electrical breakdown.

Please note that proof of purchase is required for any in-guarantee service calls.

Service details - adhesive label

When you return your guarantee card to Zanussi Ltd., you will receive a "Appliance Guarantee And Maintenance Record" together with an adhesive label. The label can be adhered to the machine or adjacent furniture.

This machine incorporates new Electronic Technology and therefore may work differently from a traditional product which you have become accustomed to. If you are concerned about the operation of the machine please study the instruction book carefully, as it contains advice about the way in which the new technology affects the operation during normal use.

PEACE OF MIND FOR TWELVE MONTHS

Zanussi standard guarantee conditions

This guarantee is in addition to your statutory and other legal rights which will not be excluded or in any way diminished by the return of this guarantee card.

We, Zanussi Ltd., undertake that if, within twelve months of the date of the purchase, this ZANUSSI appliance or any part thereof is proved to be defective by reason only of faulty workmanship or materials, we will, at our option, repair or replace the same **FREE OF ANY CHARGE** for labour, materials or carriage on condition that:

- The appliance has been correctly installed and used only on the electricity supply stated on the rating plate.
- The appliance has been used for normal domestic purposes only, and in accordance with the manufacturer's operating and maintenance instructions.
- The appliance has not been serviced, maintained, repaired, taken apart or tampered with by any person not authorised by us.

All service work under this guarantee must be undertaken by a Zanussi Service Force Centre.

Home visits are made between **8.30am** and **5.30pm** Monday to Friday. Visits may be available outside these hours in which case a **premium** will be charged.

Any appliance or defective part replaced shall become our property.

Exclusions

This guarantee does not cover:

- Damage or calls resulting from transportation, improper use or neglect, the replacement of any light bulbs or removable parts of glass or plastic.
- Costs incurred for calls to put right machines improperly installed or calls to machines outside the UK and the Republic of Ireland.
- Appliances found to be in use within a commercial or similar environment, plus those which are subject to rental agreements.
- Products of Zanussi manufacture which are **NOT** marketed by Zanussi Ltd.
- EEC Countries - The standard guarantee is applicable but subject to the owner's responsibility and cost to ensure the appliance meets the standards set by the country to which the product is taken. The Zanussi company in the country concerned will be pleased to advise further. Sight of your purchase receipt will be required by them.

